

156008



PIXLIP®

GO LIGHTBOX 085250

Aufbauanleitung
User manual

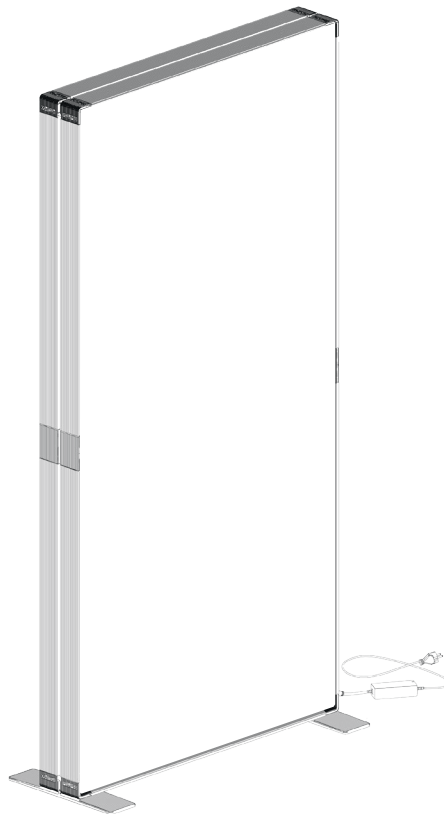

PIXLIP GO®

www.pixlippo.com

KOMPONENTEN COMPONENTS



2×
Profil 750
Profile 750



4×
Profil 1150
Profile 1150

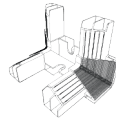

4×
Eckverbinder
Corner connector

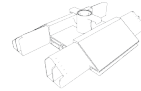

2×
Strebenhalter
Strut holder

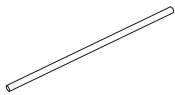

1×
Strebe 750
Strut 750

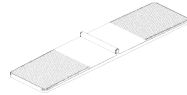

2×
Fußplatte
Base plate



8×
Print Clip
Print clip



6×
Verschlusskappe
Cover cap

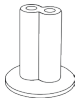

2×
Systemverbinder Top
System connector top



1×
Systemverbinder Step
System connector step



2×
LED Modul
LED Module



1×
Netzgerät
Power supply



1×
Y-Kabel
Y-cable

OPTIONAL



1×
Textil und Blockout
Textile and blockout



2×
Textil
Textile

1

2 x

750

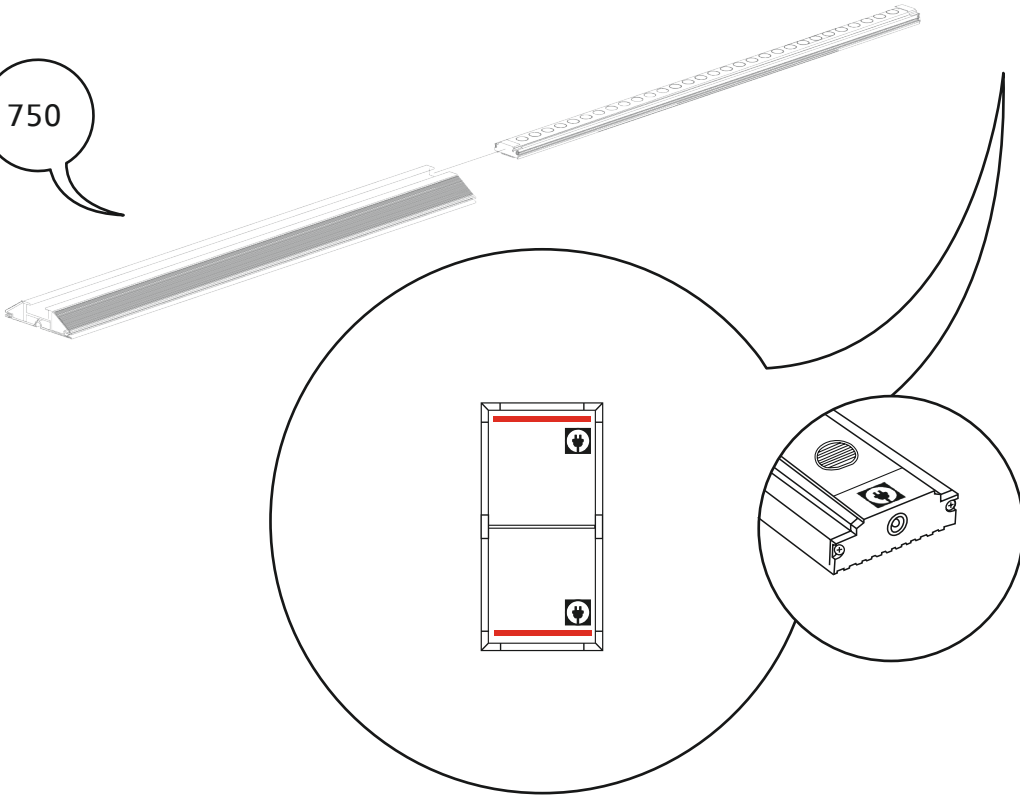

2

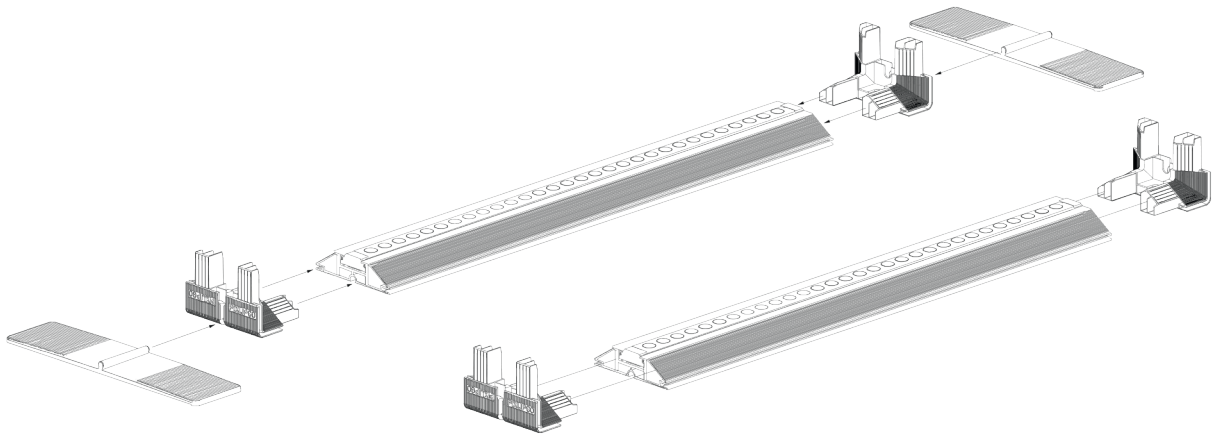

3

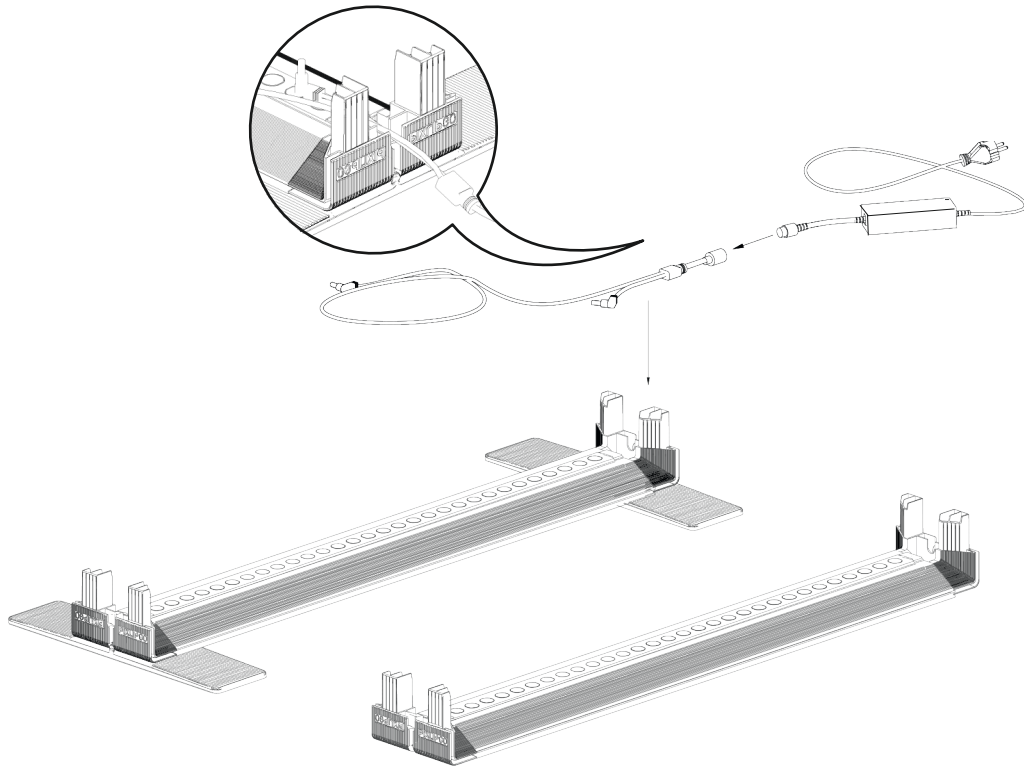

4

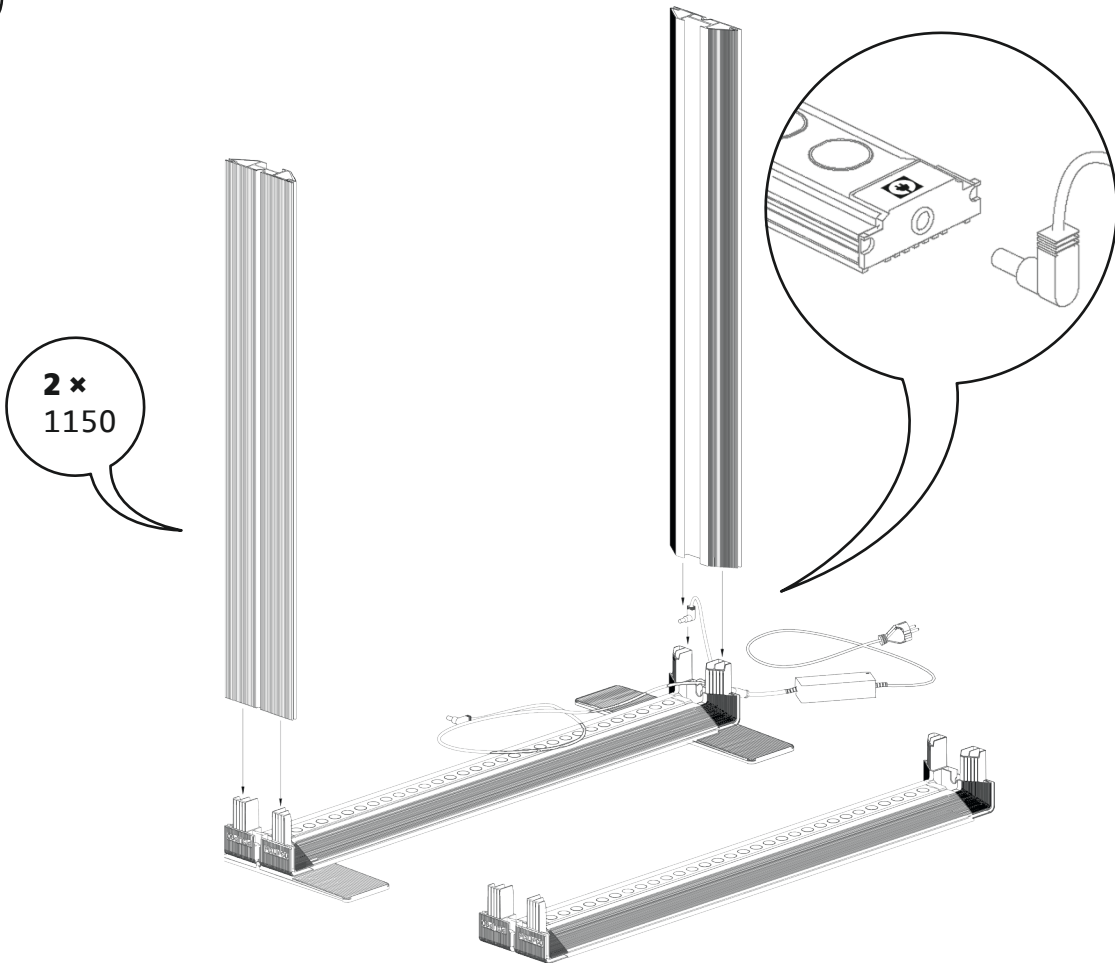

5

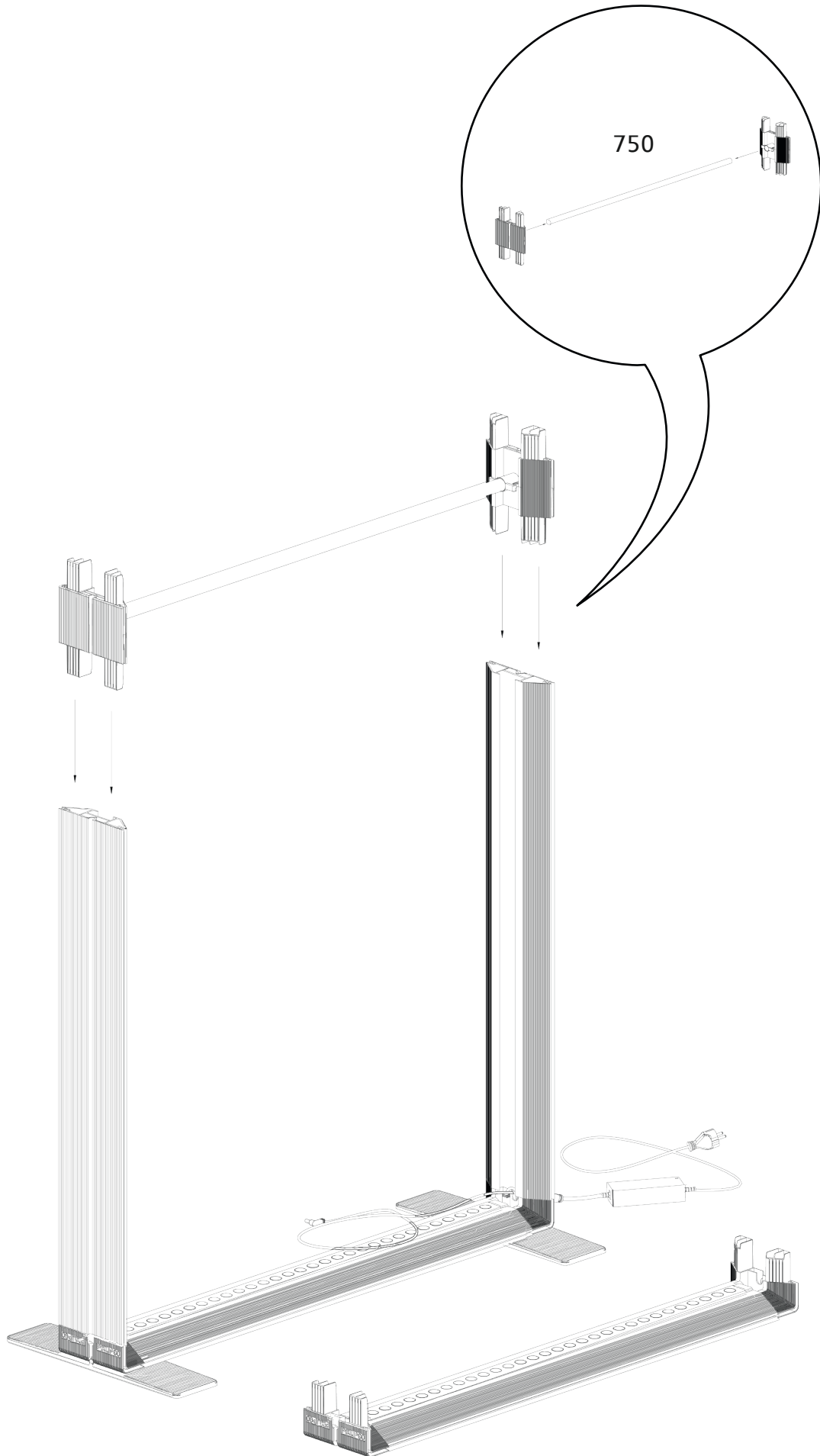

6

2 ×
1150

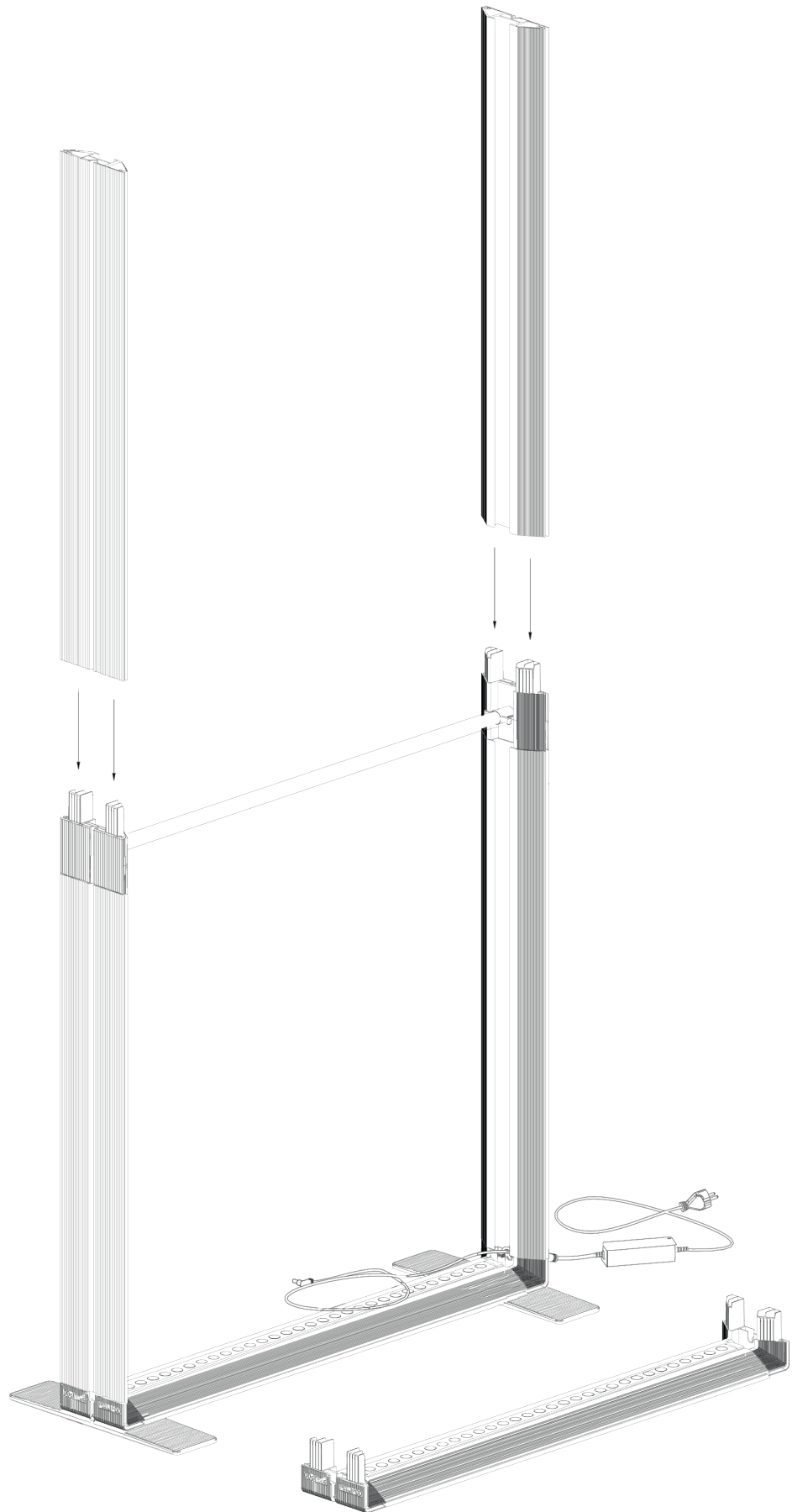

7





9



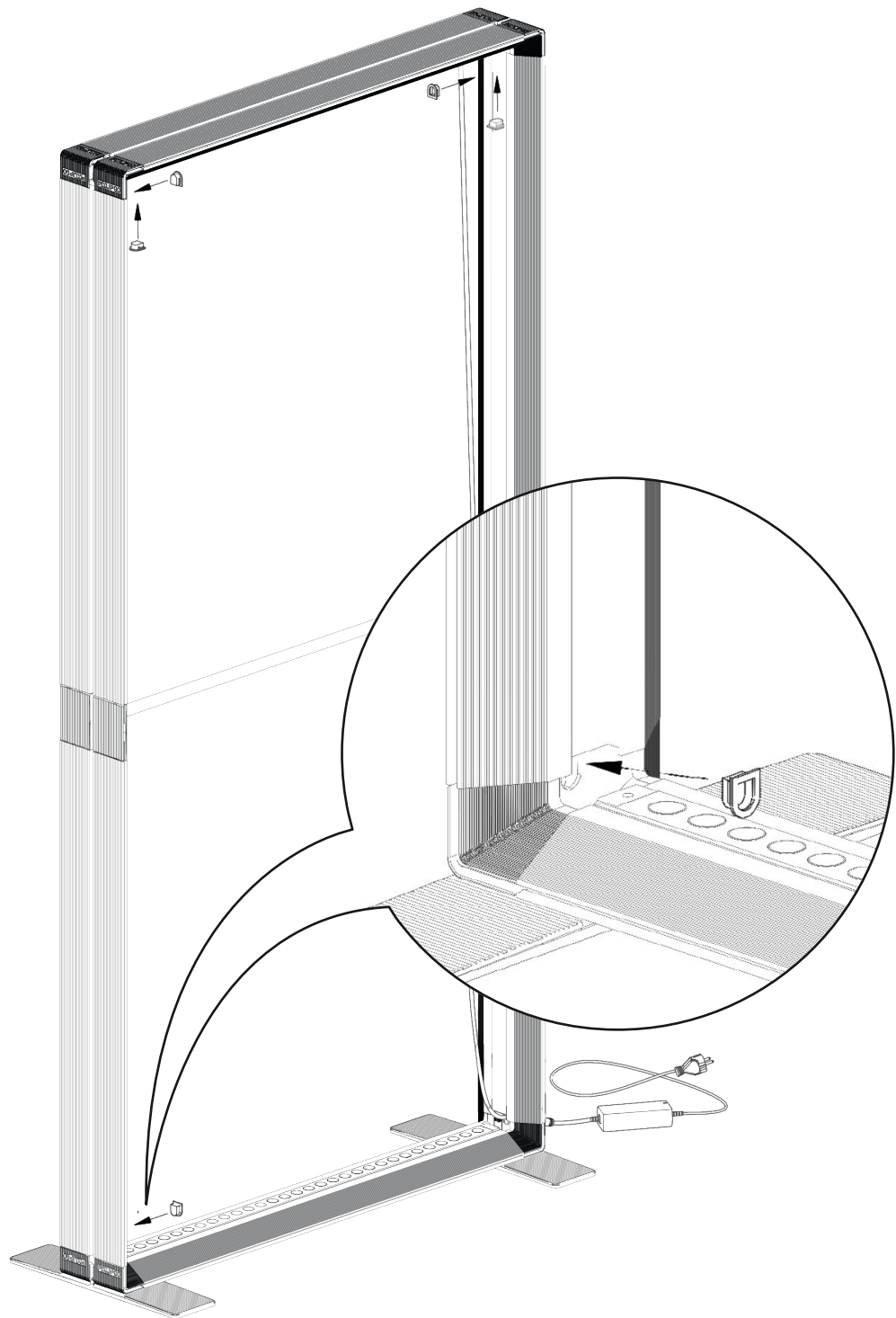

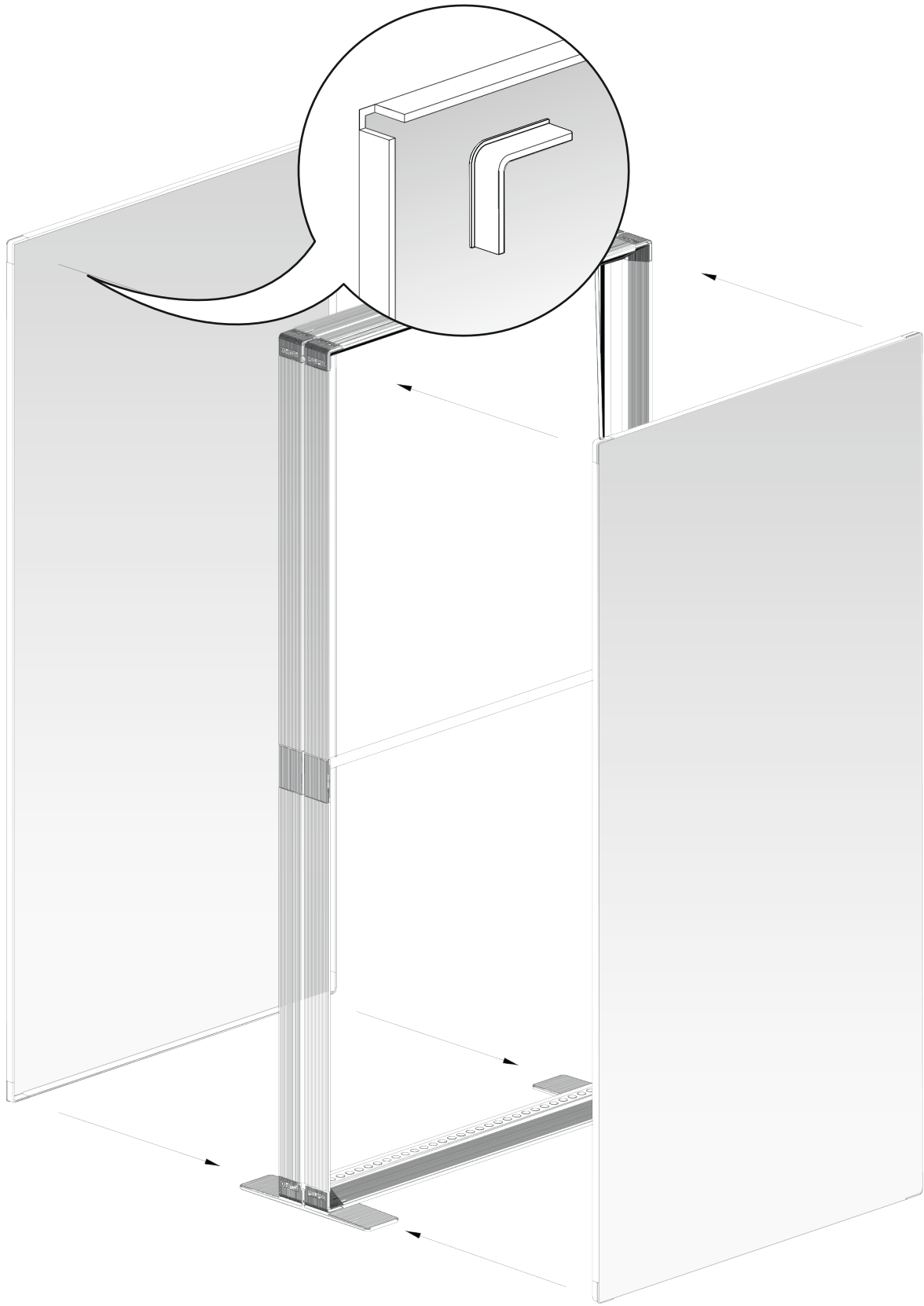



OPTIONAL





PIXLIP®

GO LIGHTBOX 085250
AUFBAUANLEITUNG
USER MANUAL

© 2018

PIXLIP GmbH
Raiffeisenstraße 17
40764 Langenfeld
Germany

info@pixlip.com
www.pixlip.com
www.pixlipgo.com

www.pixlipgo.com